

begane grond

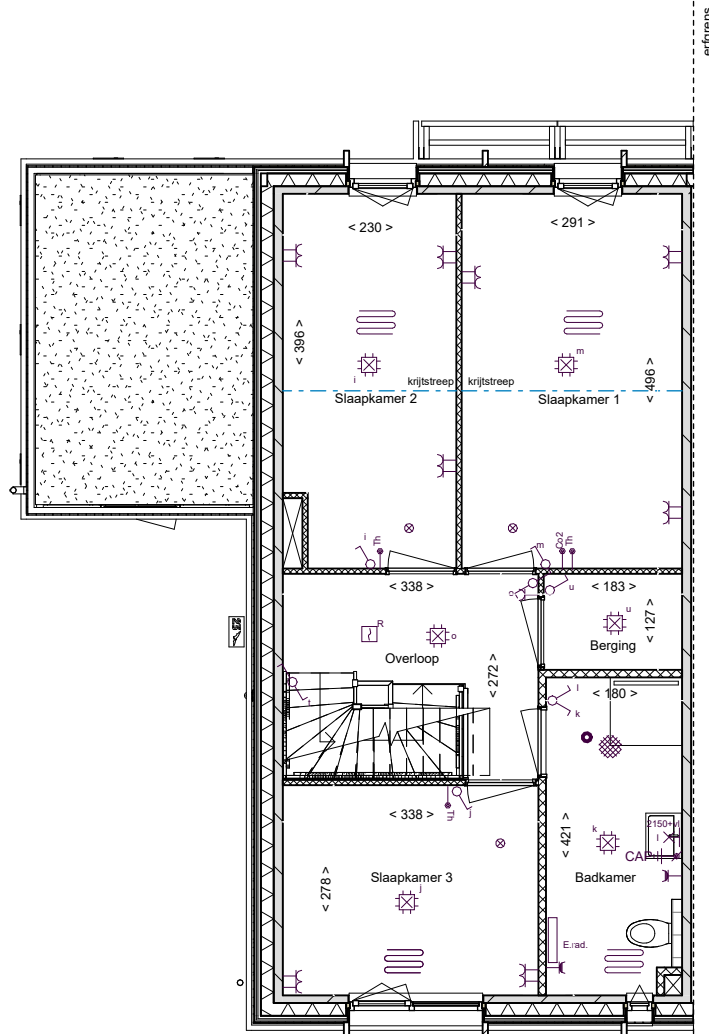

eerste verdieping

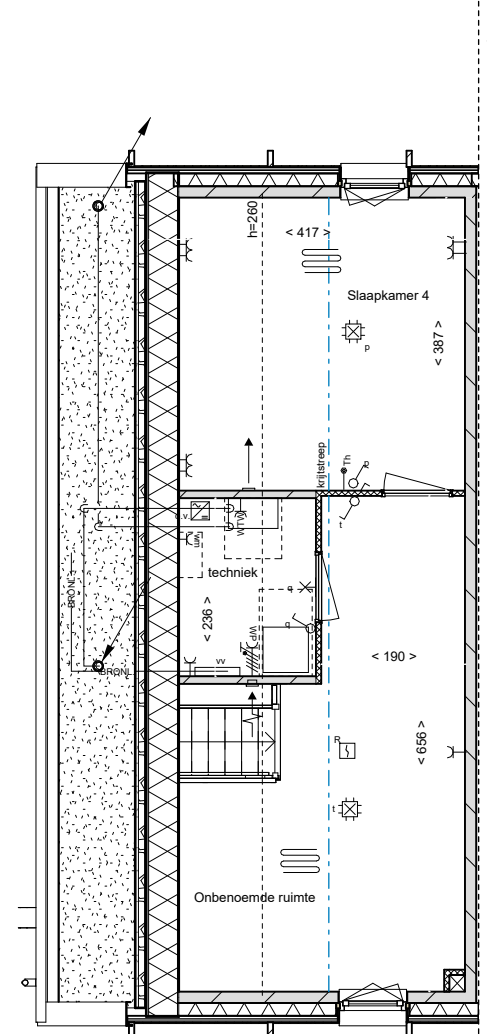

zolder

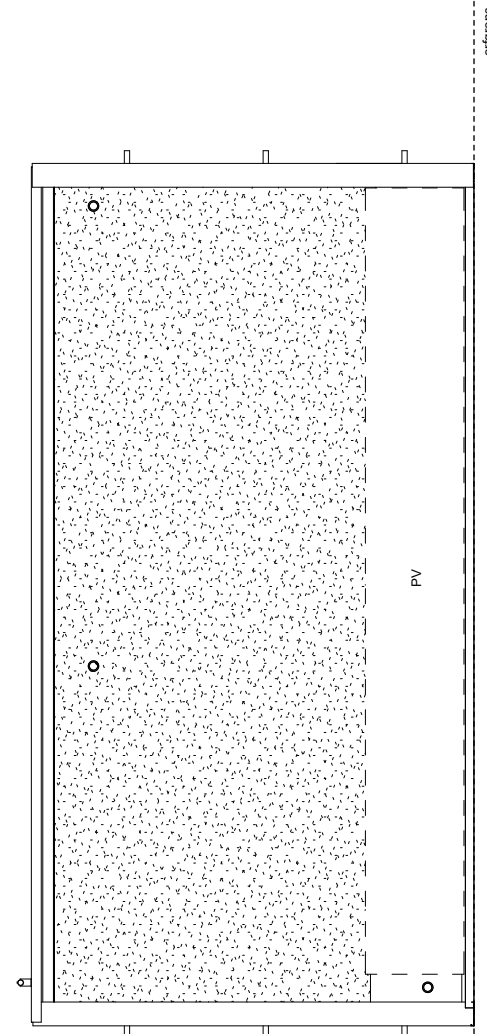

dakaanzicht

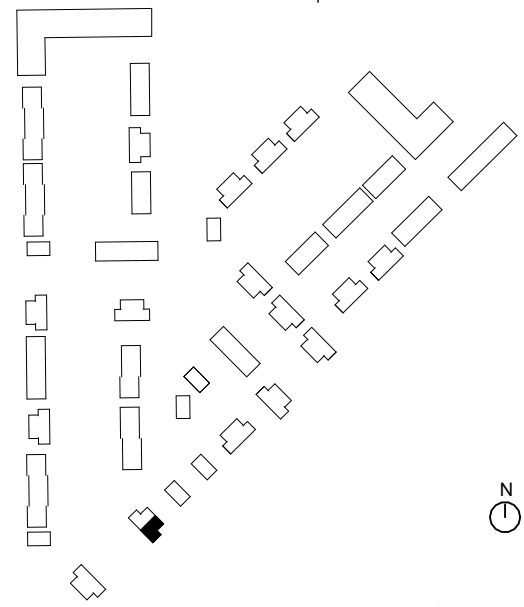

Omschrijving
Plattegronden

Onderdeel
Verkooptekening
Bouwnummer(s)
14 (2K)

tekeningnummer
VK-014-1
getekend
-

schaal
1 : 100
formaat
A3

voorlopig



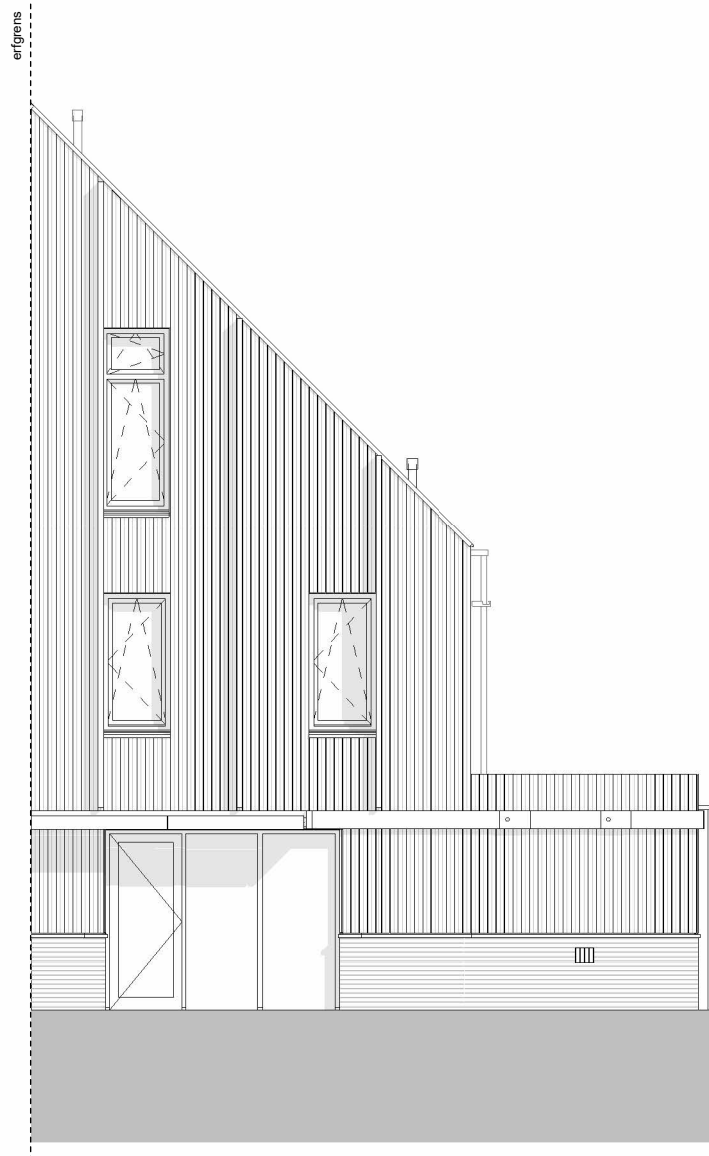

achtergevel (zuidoost)

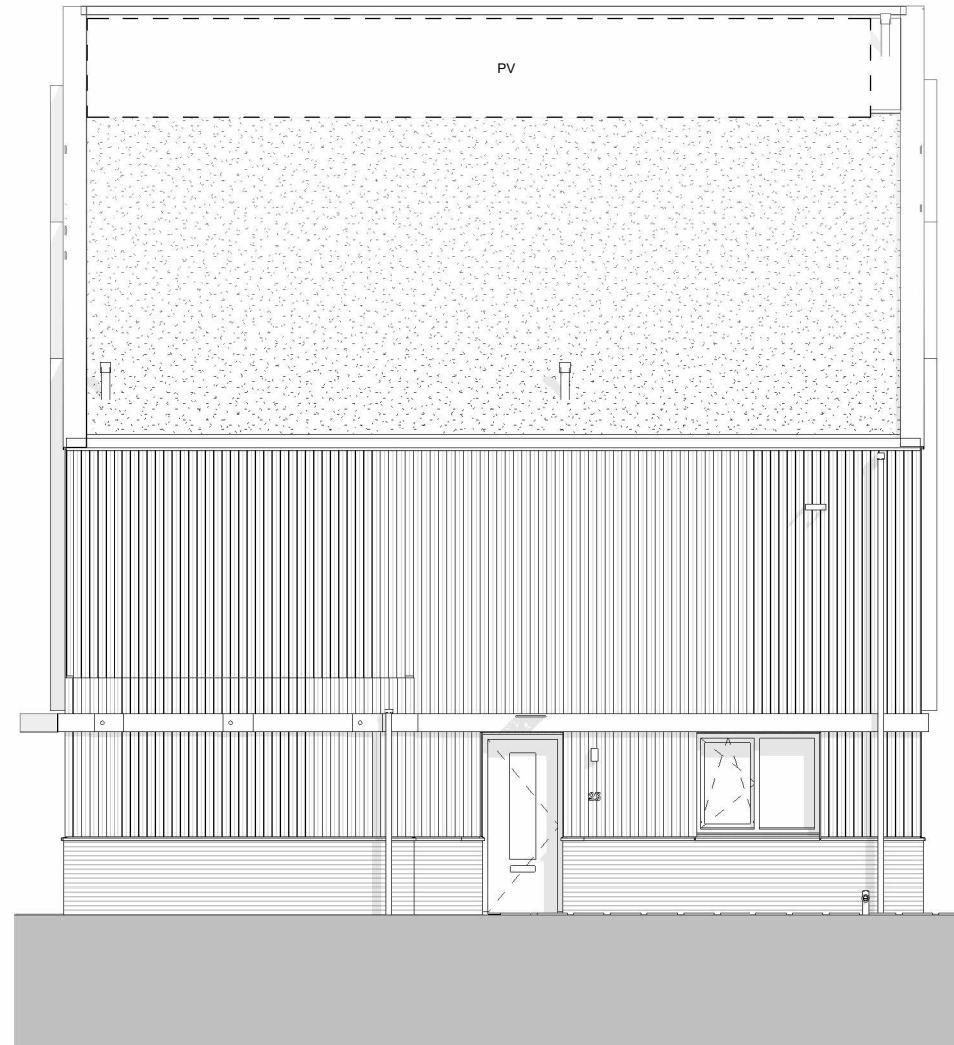

zijgevel (zuidoost)

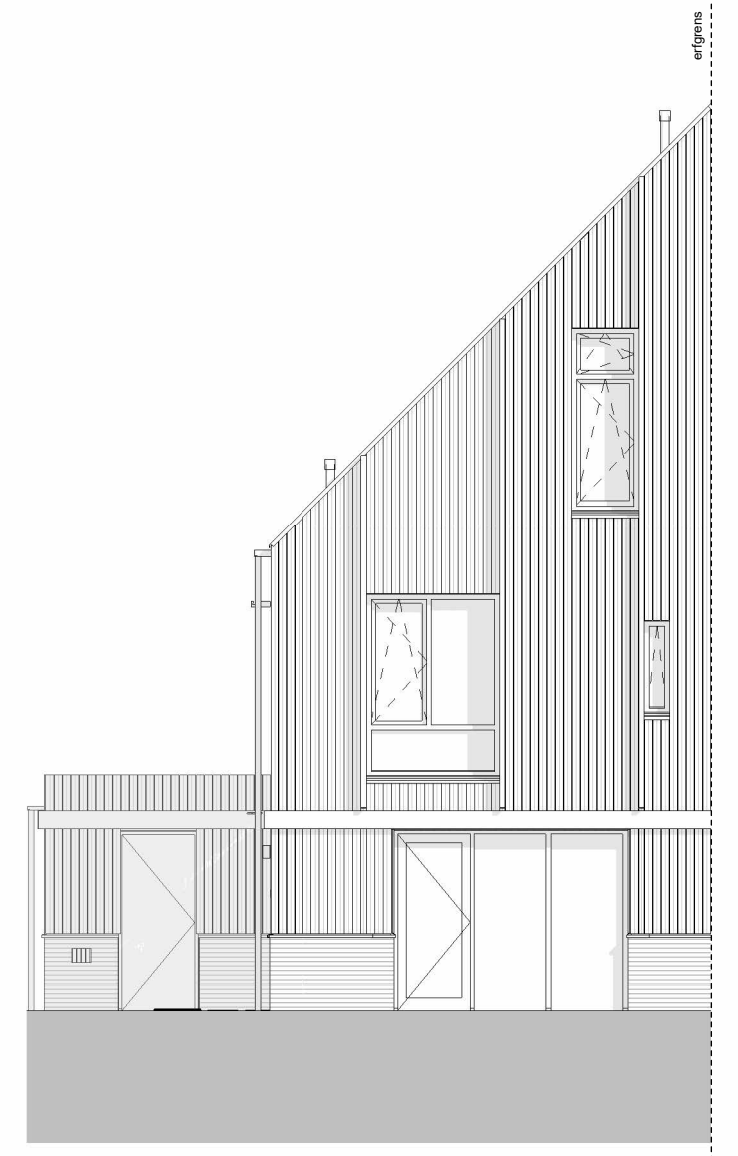

voorgevel (noordoost)

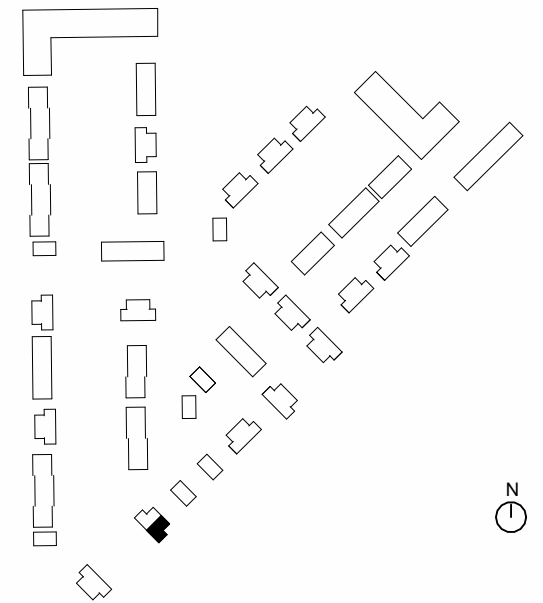

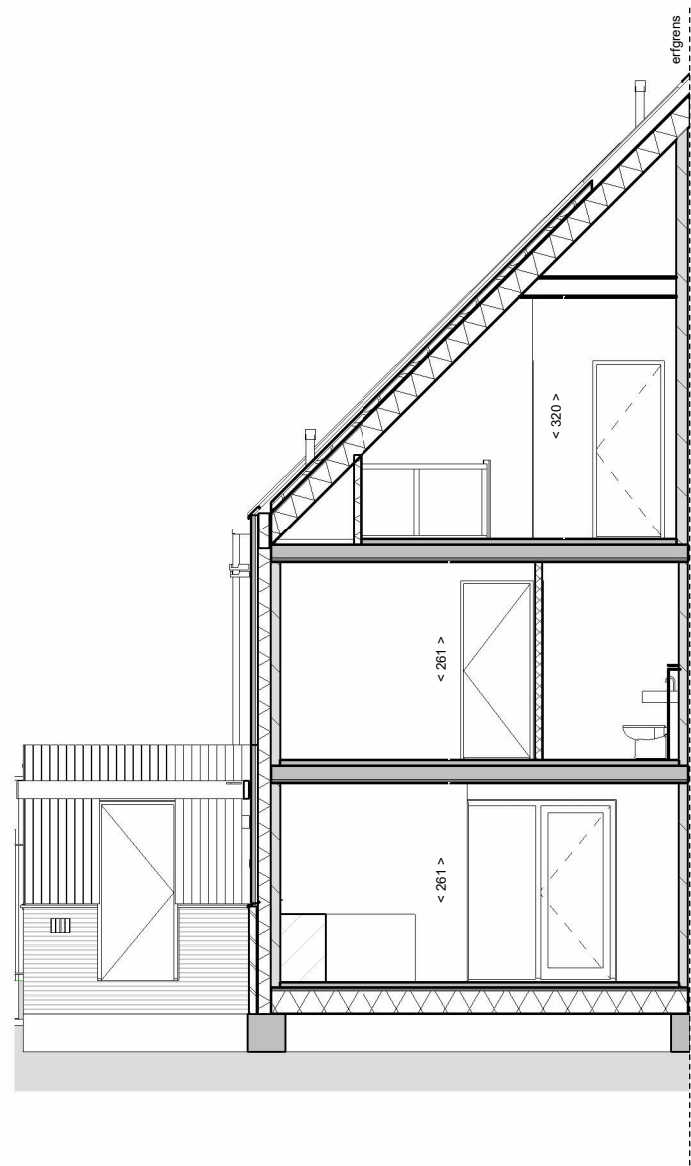

langsdoorsnede

02 tweede verdieping
+5840

01 eerste verdieping
+2920

00 begane grond
+0

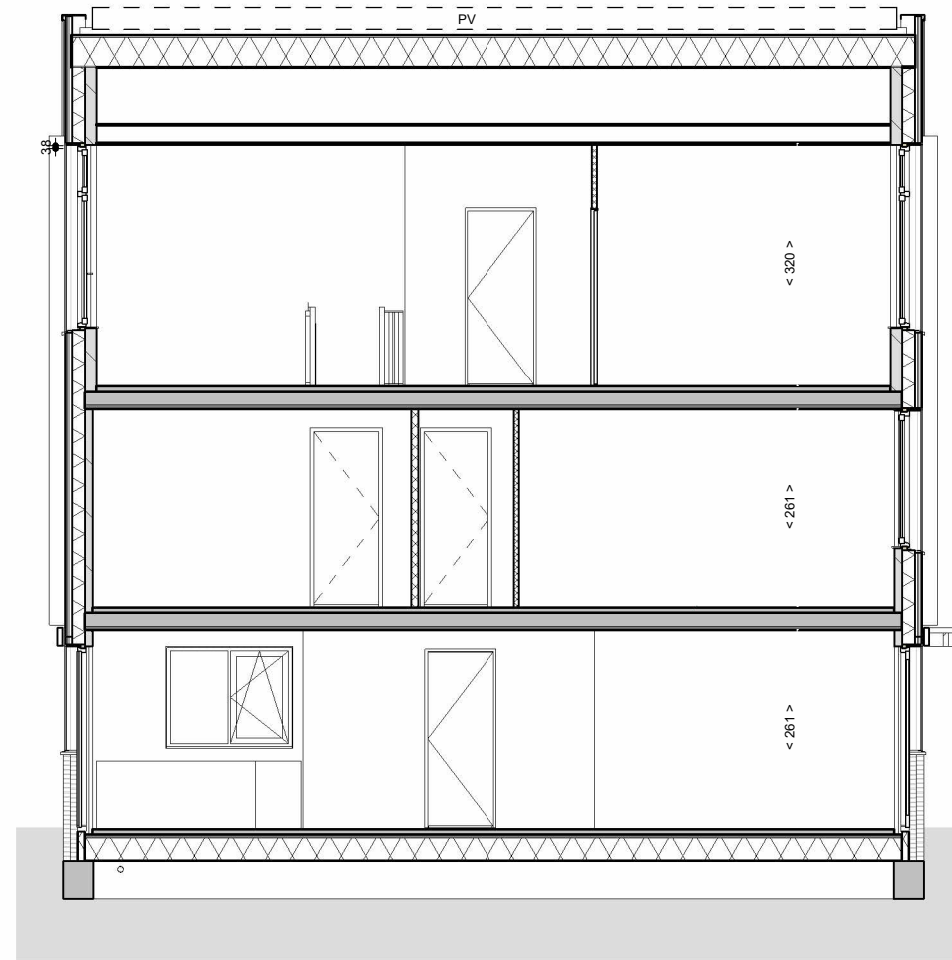

dwarsdoorsnede

02 tweede verdieping
+5840

01 eerste verdieping
+2920

00 begane grond
+0

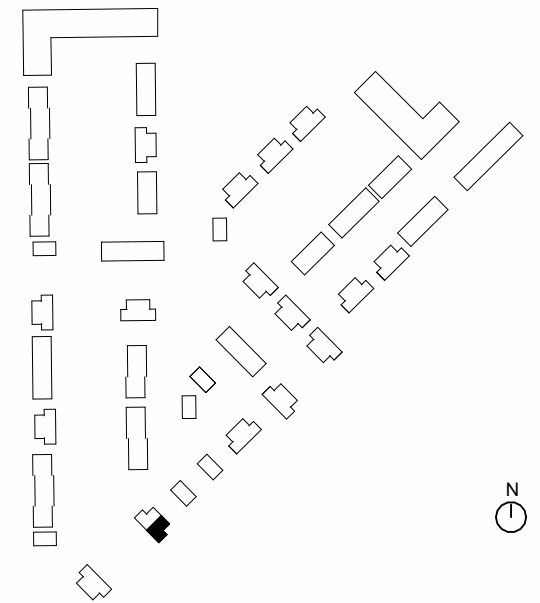

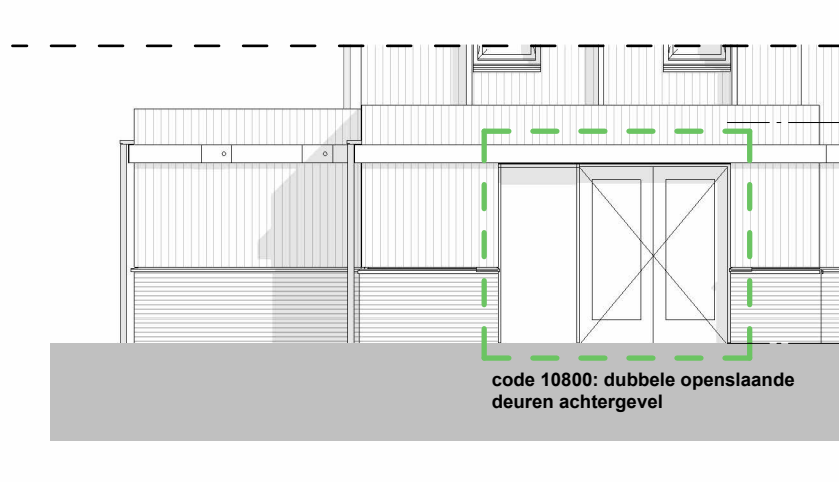

code 10140: uitbouw achtergevel 120cm

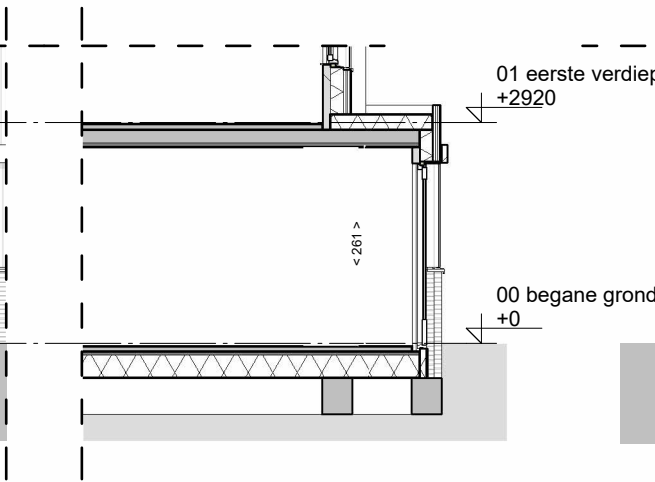

code 10140 / 50: uitbouw achtergevel 120cm

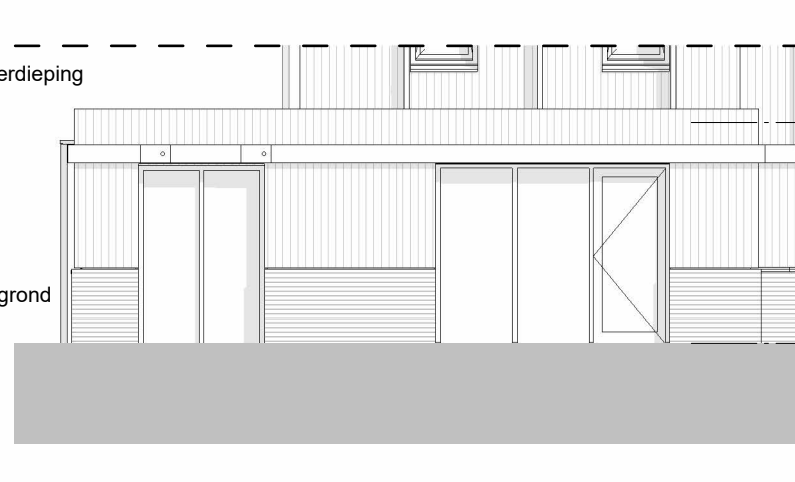

code 10150: uitbouw achtergevel en berging 120cm

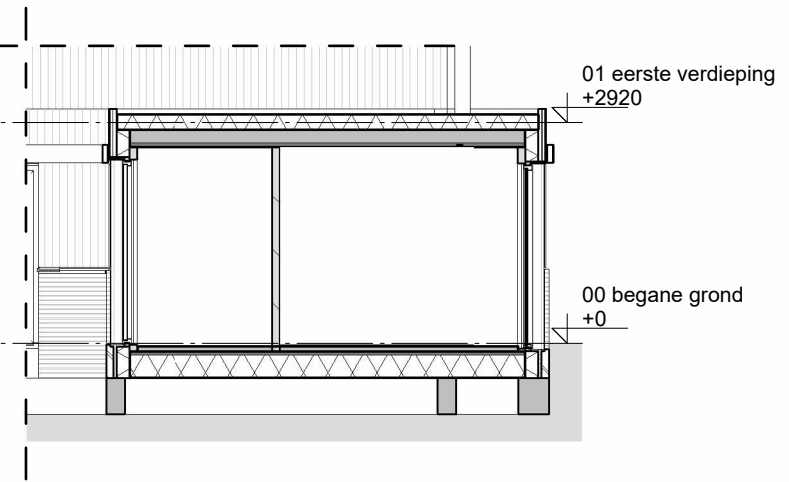

code 10120: uitbouw achtergevel en berging 120cm

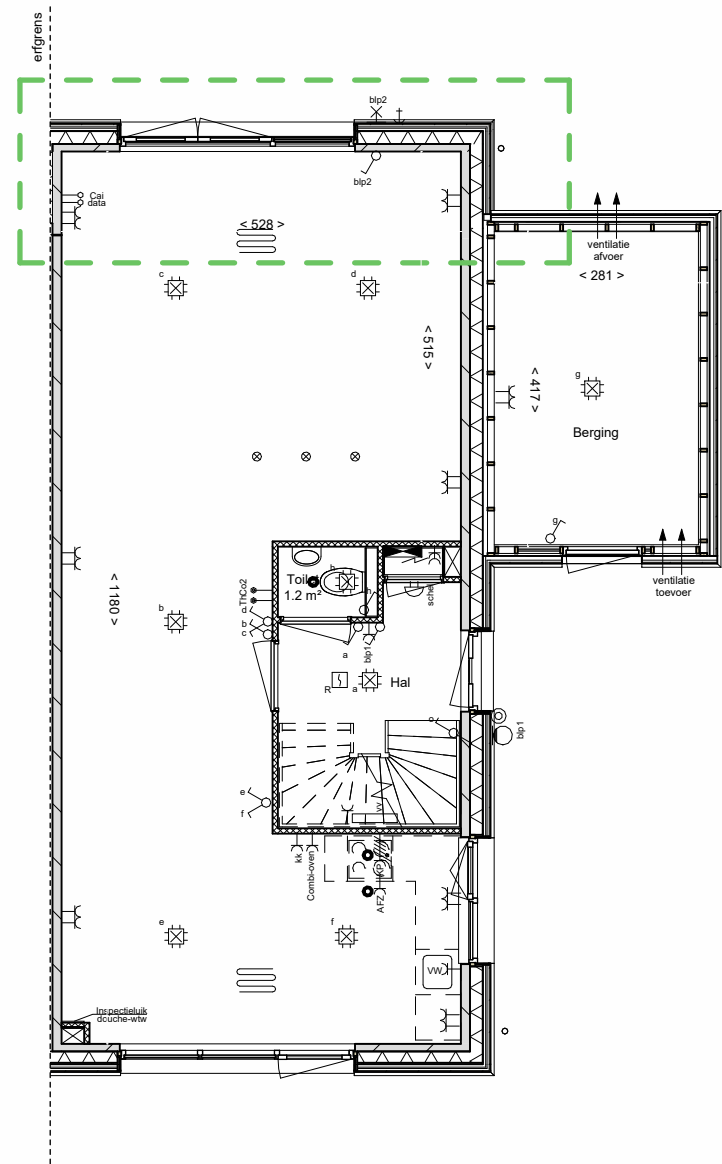

begane grond

code 10140: uitbouw achtergevel 120cm

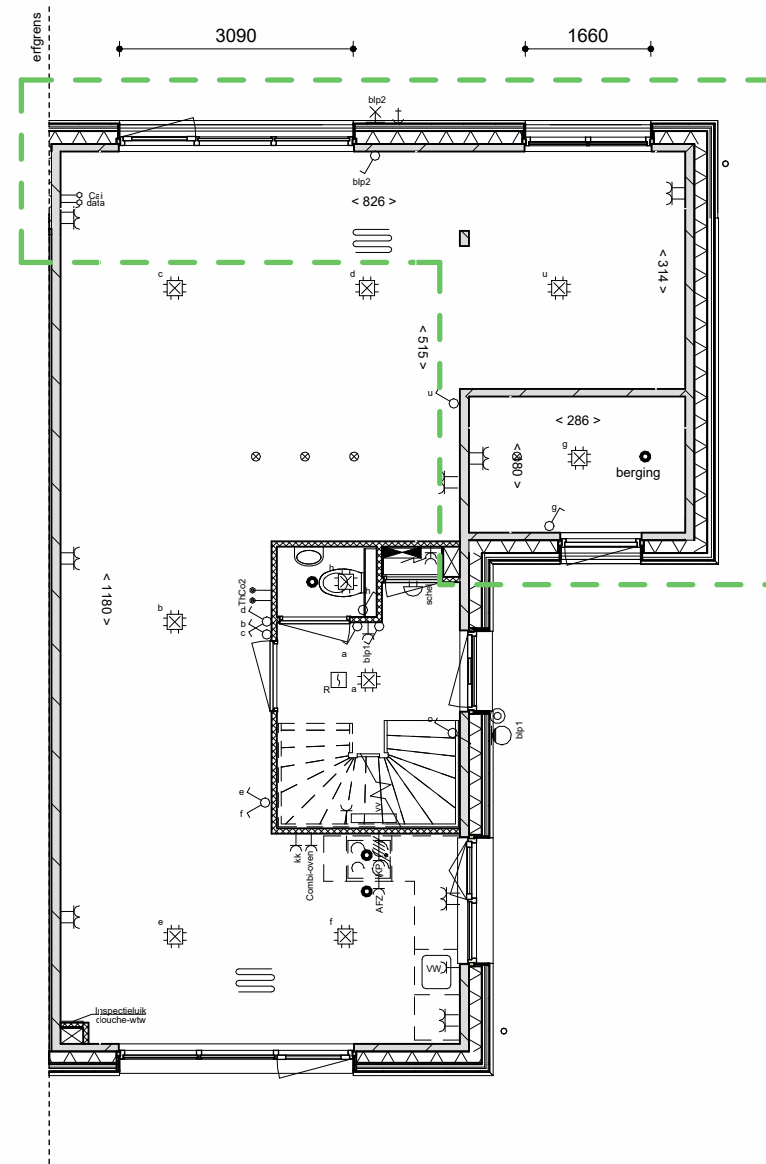

begane grond

code 10150: uitbouw achtergevel en berging 120cm

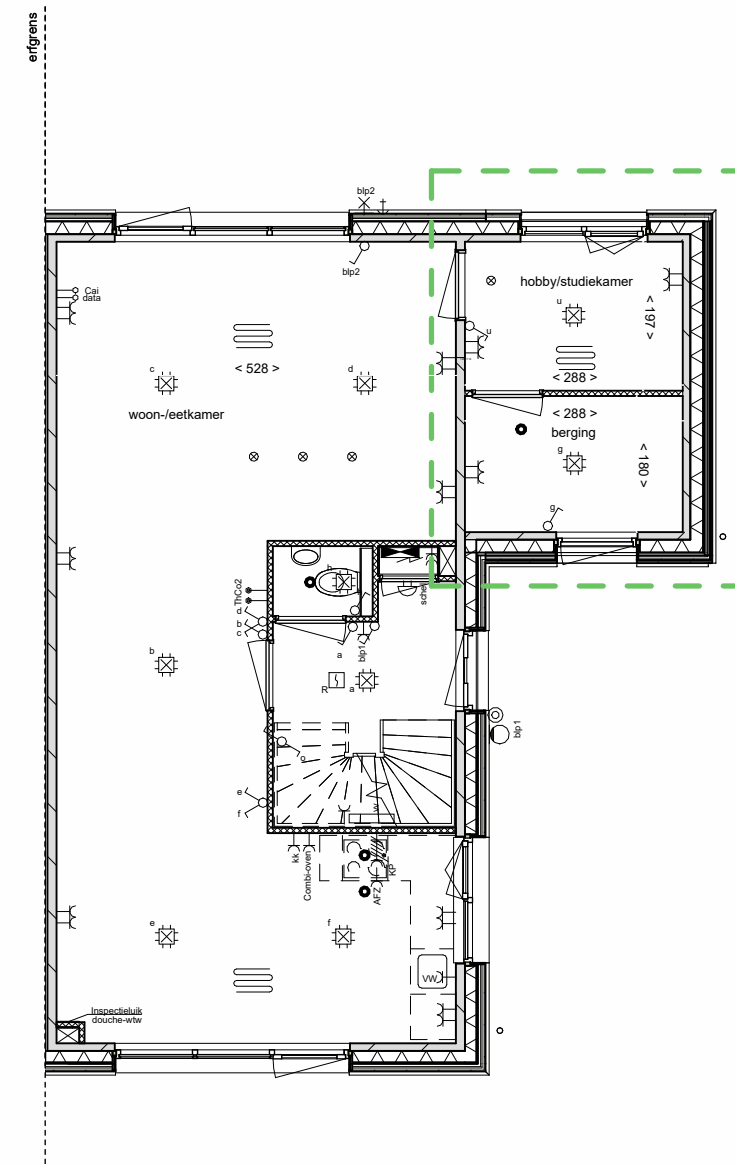

begane grond

code 12010: splitsing berging

NB:
Kopersopties slechts ter indicatie van de extra ruimte en bijbehorende gevelopeningen; materialisatie van de gevel (hout of metselwerk) wijkt mogelijk af van uw bouwnummer.

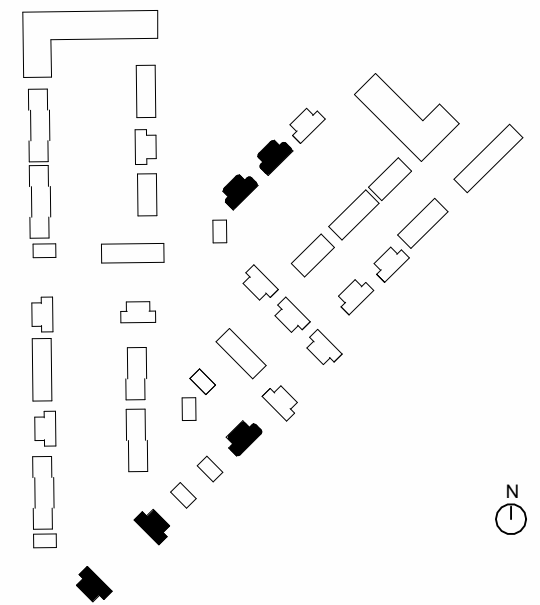

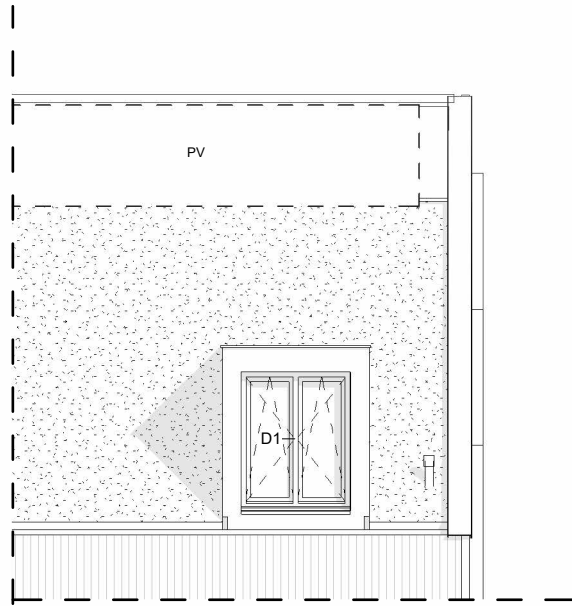

code 10510: dakkapel

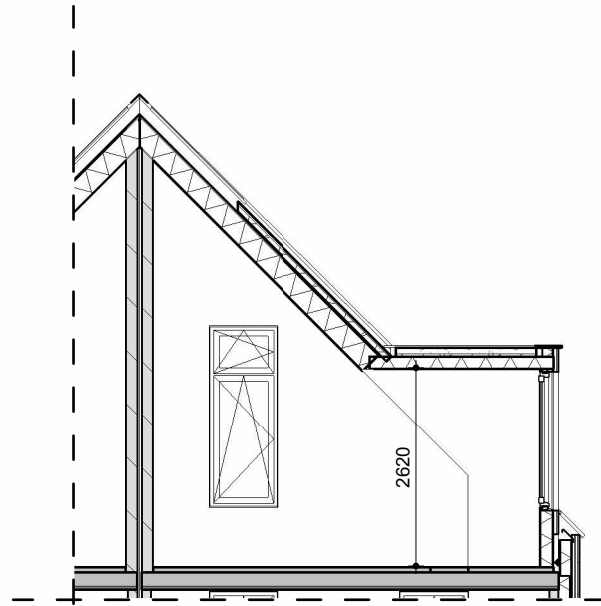

code 10510: dakkapel

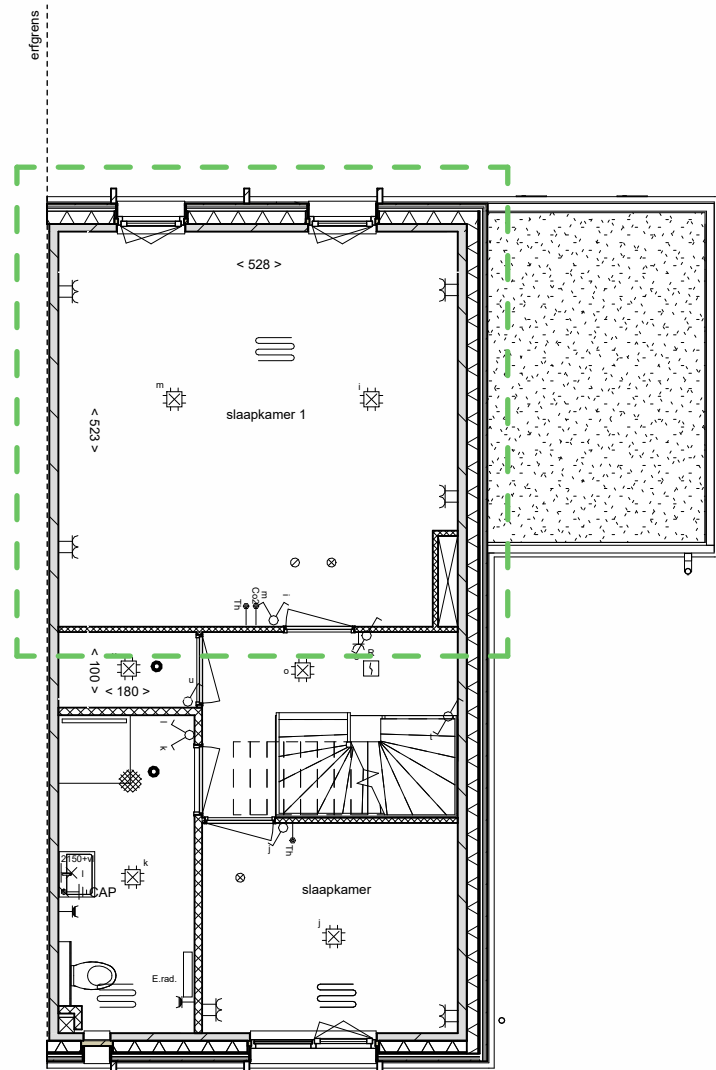

eerste verdieping

code 12145: samengevoegde slaapkamers

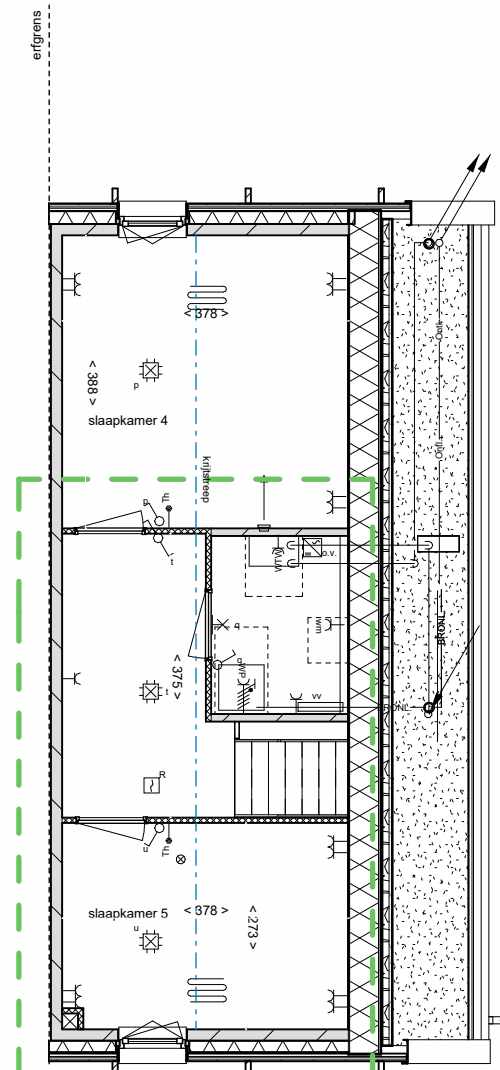

zolder

code 12410: splitsing zolder

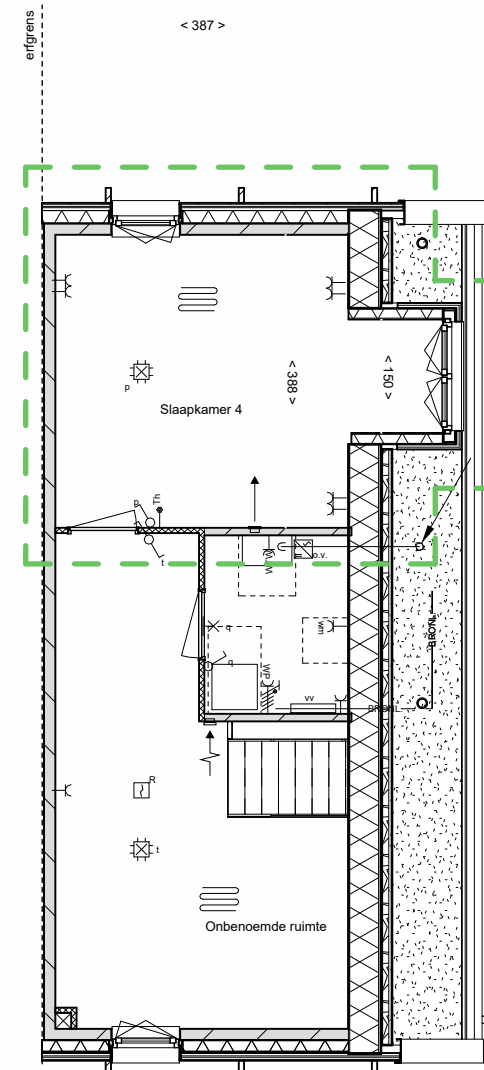

zolder

code 10510: dakkapel

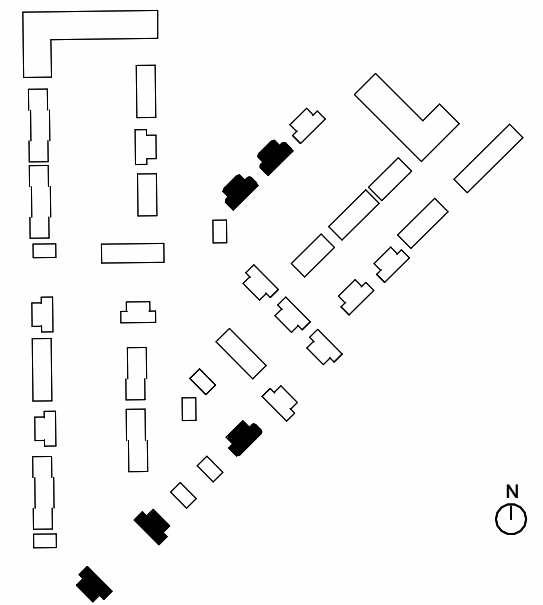

NB:
Kopersopties slechts ter indicatie van de extra ruimte en
bijbehorende gevelopeningen; materialisatie van de gevel
(hout of metselwerk) wijkt mogelijk af van uw
bouwnummer.



Omschrijving
Optietekening

voorlopig

Onderdeel	tekeningnummer	schaal	formaat
Verkooptekening	VK-014-5	1 : 100	A3
Bouwnummer(s)	getekend		
10,11,14-17,105-108	-		